

VALOR AIR PLUS

ENDLESS POSSIBILITIES



VALOR AIR PLUS Mid-Tower PC Chassis

XPG VALOR AIR PLUS mid-tower PC chassis offers a robust platform for future upgrades, accommodating mid-to-high-end components, including most RTX 40 series GPUs. Its high-airflow magnetic front panel enhances visual appeal, especially with RGB fans, while ensuring superior ventilation. With 4x pre-installed 120mm ARGB daisy-chained fans included in select models, it delivers optimal cooling performance right out of the box.



Black, 1 Fan Included



White, 4 ARGB Fans Included



Black, 4 ARGB Fans Included

Multiple Options to Suit Your Needs



Versatile I/O Panel with 2x USB 3.2 Ports

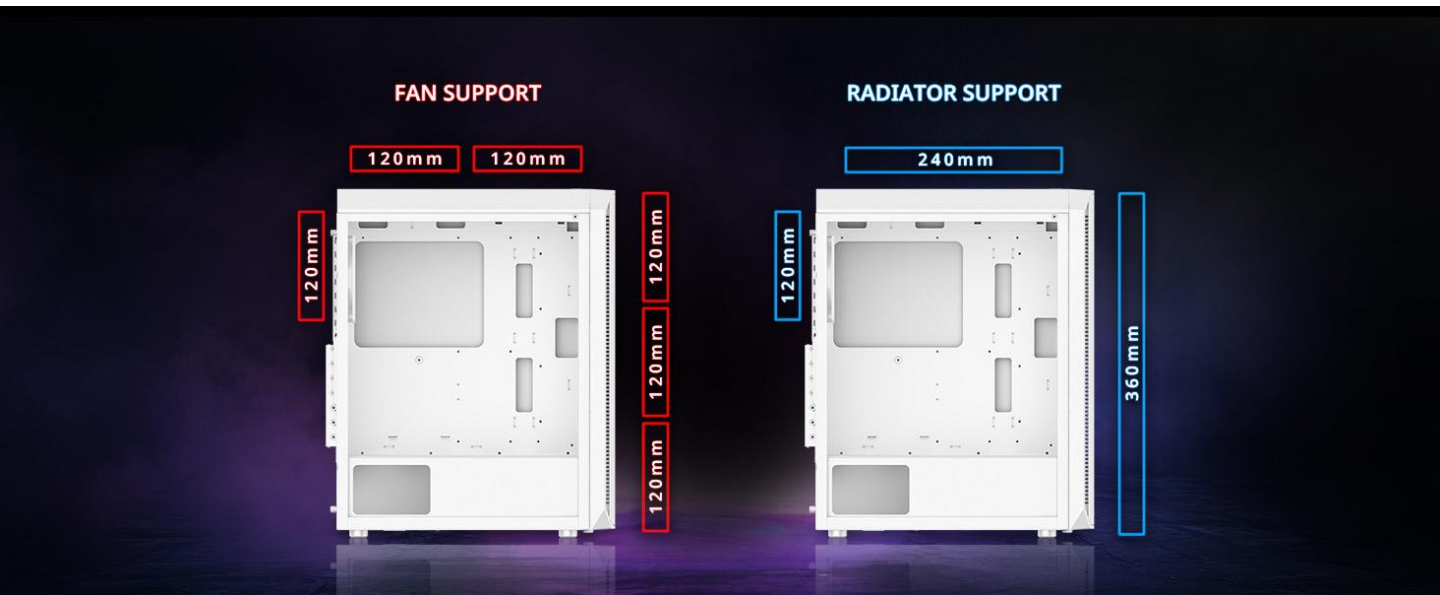

Comprehensive Cooling Capacity with 240mm Radiator on Top and 360mm at Front

Fan Support	Rear Top Front	120mm x 1 120mm x 2 120mm x 3
Radiator Support	Rear Top Front	120mm 240mm 360/240mm



High-Airflow Magnetic Front Panel

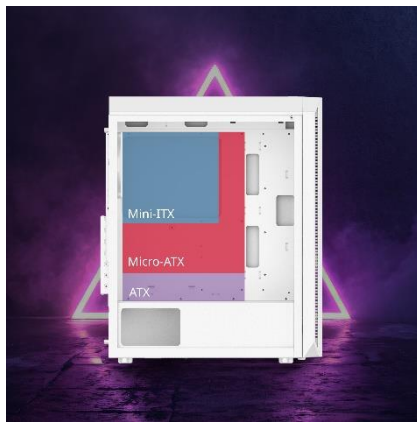

Supports Mini-ITX, Micro-ATX, and ATX Motherboards



Supports Graphics Cards up to 340mm Long



Supports Air Coolers up to 160mm Tall

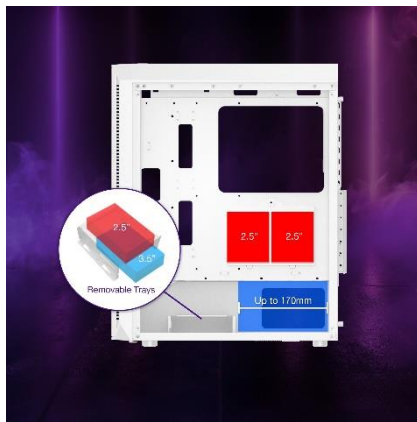

Supports up to 3x 2.5\"/>

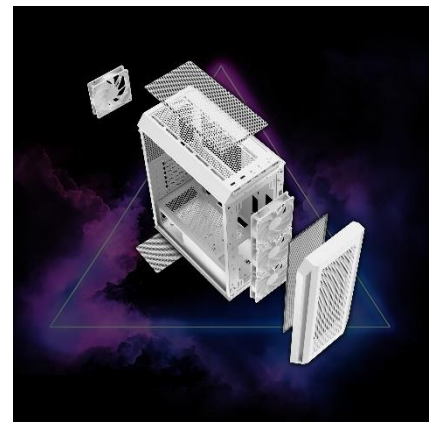

3 Removable Dust Filters Included













Features

- High-airflow magnetic front panel design provides excellent airflow to your system.
- Supports mini-ITX, micro-ATX, and ATX motherboards.
- Supports cooling configurations with up to 6x 120mm fans and a 360mm radiator.
- Supports graphics cards up to 340mm long, accommodating most of the RTX 40 series.
- Up to 4x pre-installed 120mm ARGB daisy-chained fans (depending on the model).
- Supports up to 3x 2.5" SSD or 2x 3.5" HDD with a removable HDD tray.
- 3 removable dust filters included.

Specification

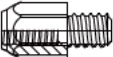
Color	Black / White	
Motherboard Support	ATX, Micro-ATX , Mini-ITX	
Dimensions (H*W*D)	482 x 200 x 400mm	
Material	SPCC	
Side Panel	3mm Tempered Glass	
PCIe Slots	7	
2.5"/3.5" Drive Bays	2	
2.5" Drive Bays	2	
Pre-Installed Fan(s)*	4 x 120mm ARGB Fans (VALORAIRPLUSMTA) 1 x 120mm Fan (VALORAIRPLUSMTN) *Depending on the model	
Fan Support	Rear Top Front	120mm x 3 120mm x 2 120mm x 1
Radiator Support	Rear Top Front	120mm 240mm 360/240mm
I/O Panel	x2 USB 3.2 x1 Hybrid Audio Port x1 Reset Button x1 Power Button	
Compatibility	GPU Length: Up to 340mm (with pre-installed fans) CPU Air Cooler Height: Up to 160mm PSU Length: Up to 170mm	
Package Contents	1. VALOR AIR PLUS Chassis 2. VALOR AIR PLUS Quick Installation Guide 3. Accessories	
Warranty	2 Years	

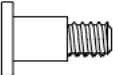
Accessories Included in Box

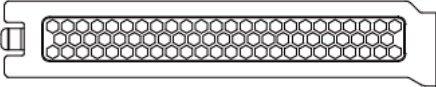
x1			Nut Setter
x18			Motherboard & SSD Screws
x12			PSU & PCI Card Strip Screws
x8			HDD Screws
x3			Motherboard Standoff
x2			HDD Step Screws
x5			Cable Ties
x6			PCI Card Strip



Ordering Information

	Color	Black
	Product Model Number	VALORAIRPLUSMTA-BKCWW
	Part Number	75261537
	EAN & JAN Code	4711085948502
	UPC Code	842243033854
	Gross Weight	6.1kg
	Color	White
	Product Model Number	VALORAIRPLUSMTA-WHCWW
	Part Number	75261538
	EAN & JAN Code	4711085948519
	UPC Code	842243033861
	Gross Weight	6.1kg
	Color	Black
	Product Model Number	VALORAIRPLUSMTN
	Part Number	75261536
	EAN & JAN Code	4711085948496
	UPC Code	842243033847
	Gross Weight	5.73kg

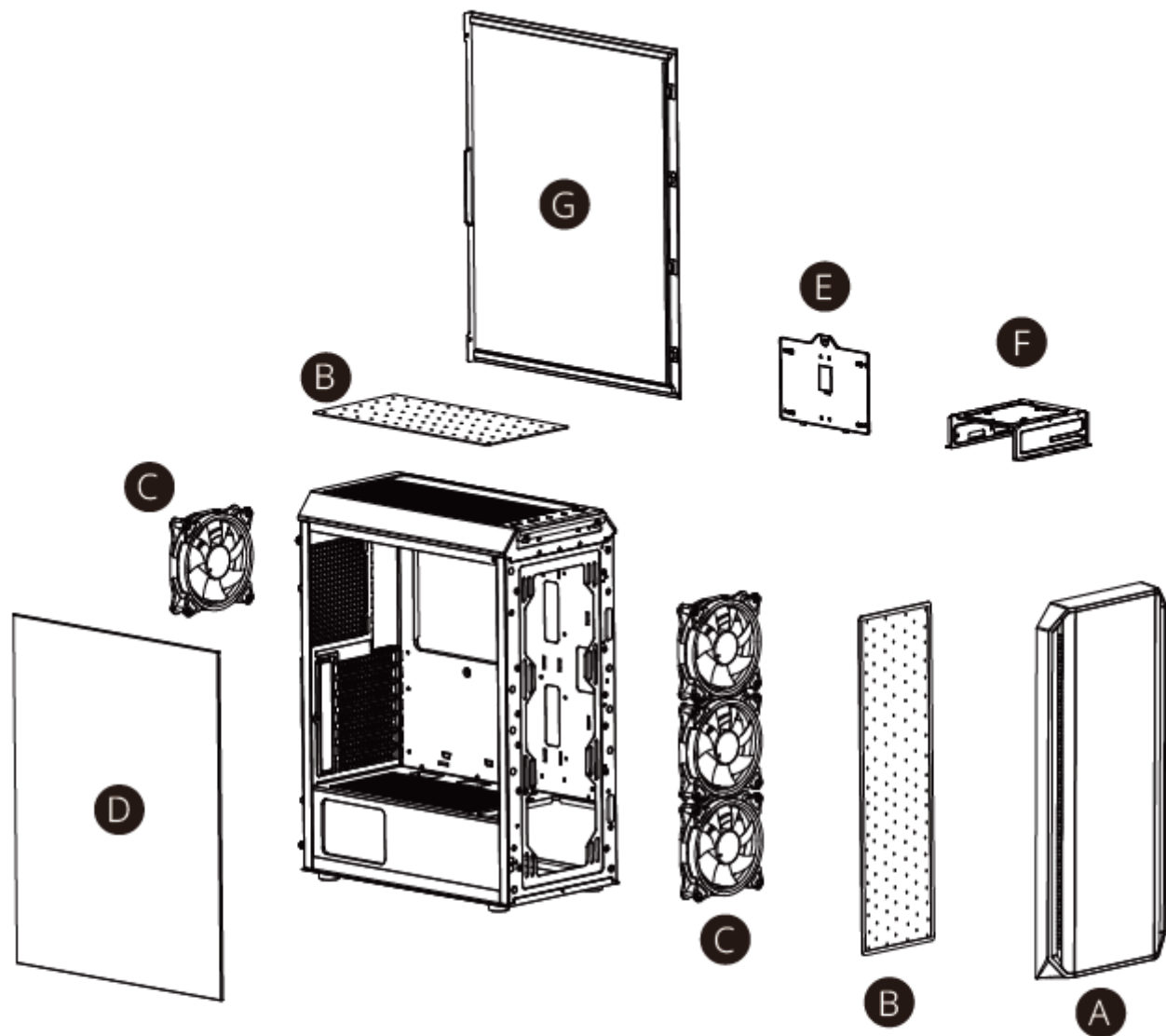

- A** ----- Magnetic Front Panel
- B** ----- Removable Dust Filter
- C** ----- 4 x 120mm ARGB Fans (VALORAIRPLUSMTA)
1 x 120mm Fan (VALORAIRPLUSMTN)
- D** ----- Glass Side Panel
- E** ----- 2.5" HDD/SSD Brackets
- F** ----- 2.5" / 3.5" HDD/SSD Tray
- G** ----- Steel Panel

